

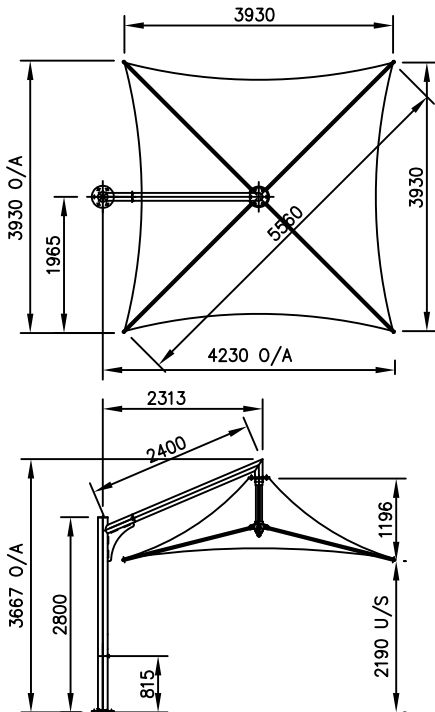

VISTA 4.0M SQUARE CANTILEVER UMBRELLA - V40S

METRIC



CODE: V40S
 VISTA 4.0M SQUARE CANTILEVER

IMPERIAL

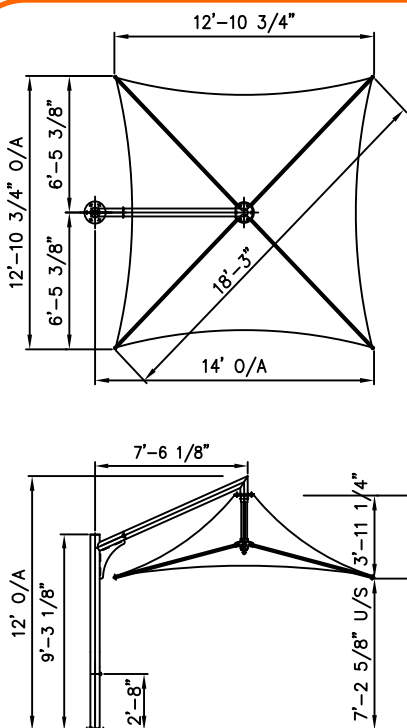

CODE: V40SC
 VISTA 14 FT. SQUARE CANTILEVER

Specifications:

- . Low maintenance, heat reflective, UV treated, fully welded membrane.
- . Stainless steel edge cable for even tension of roof Material.
- . Mast and cantilever arm are structural grade steel Which is galvernised and then powdercoated.
- . Arms are structural grade aluminium.
- . Retractable winding mechanism allowing for the arms To collapse in extreme weather
- . 5 year warranty on the frame.
- . 2 year warranty on the canopy
- . Engineered wind rated 112 kph - 75 MPH open & 150 kph - 93 MPH closed

Options:

- . PVC Curtains
- . Lighting
- . Screen Printing
- . Rain Lips
- . Link Panels joining umbrellas
- . 360 Degree Swivel Base

